

Operation Manual

# Interface I-180



## **Imprint**

Product Identification:  
Operation Manual (Original) Interface I-180  
11594509

Publication date: 03.2024

Version A

BÜCHI Labortechnik AG  
Meierseggstrasse 40  
Postfach  
CH-9230 Flawil 1  
E-Mail: [quality@buchi.com](mailto:quality@buchi.com)

BUCHI reserves the right to make changes to the manual as deemed necessary in the light of experience, especially with respect to structure, illustrations and technical details.  
This manual is copyrighted. Information from it may neither be reproduced, distributed, or used for competitive purposes, nor made available to third parties. The manufacture of any component with the aid of this manual without prior written agreement is also prohibited.

## Table of contents

<b>1</b>	<b>About this document.....</b>	<b>5</b>
1.1	Mark-ups and symbols.....	5
1.2	Trademarks.....	5
1.3	Connected instruments.....	5
<b>2</b>	<b>Safety.....</b>	<b>6</b>
2.1	Intended use.....	6
2.2	Use other than that intended.....	6
2.3	Staff qualification.....	6
2.4	Personal protective equipment.....	7
2.5	Warning notices in this document.....	7
2.6	Warning symbols.....	7
2.7	Residual risks.....	7
	2.7.1 Faults during operation.....	7
2.8	Modifications.....	7
<b>3</b>	<b>Product description.....</b>	<b>9</b>
3.1	Description of function.....	9
3.2	Configuration.....	9
	3.2.1 Front view.....	9
	3.2.2 Rear view.....	10
	3.2.3 Connections.....	10
	3.2.4 Display layout.....	11
	3.2.5 Display symbols.....	11
3.3	Scope of delivery.....	12
3.4	Type plate.....	12
3.5	Technical data.....	12
	3.5.1 Interface I-180.....	12
	3.5.2 Ambient conditions.....	13
	3.5.3 Materials.....	13
	3.5.4 Installation site.....	13
<b>4</b>	<b>Transport and storage.....</b>	<b>14</b>
4.1	Transport.....	14
4.2	Storage.....	14
4.3	Lifting the instrument.....	14
<b>5</b>	<b>Installation.....</b>	<b>15</b>
5.1	Installing the interface.....	15
	5.1.1 Installing on the Rotavapor®.....	15
	5.1.2 Installing on the vacuum pump.....	16
	5.1.3 Installing on a laboratory stand.....	17
5.2	Connecting the BUCHI communication cable.....	17
5.3	Connecting vacuum.....	18
	5.3.1 Connecting the vacuum pump.....	18
	5.3.2 Connecting the valve unit.....	18

<b>6</b>	<b>Operation</b> .....	<b>20</b>
6.1	Main functions in p set mode.....	20
6.1.1	Start or hold the vacuum control.....	20
6.1.2	Changing the set pressure.....	20
6.1.3	Stop the vacuum control.....	20
6.1.4	Aerating the system.....	21
6.2	Main functions in cont mode.....	21
6.2.1	Starts or holds the vacuum pump.....	21
6.2.2	Control the vacuum pump speed.....	21
6.2.3	Stop the vacuum pump.....	22
6.2.4	Aerating the system.....	22
6.3	Settings.....	22
6.3.1	Setting the pressure.....	22
6.3.2	Setting the pump speed.....	23
6.3.3	Setting to default settings.....	24
6.4	Advanced settings.....	24
6.4.1	Advanced settings with vacuum pump.....	24
6.4.2	Advanced settings with valve unit.....	25
<b>7</b>	<b>Cleaning and servicing</b> .....	<b>27</b>
7.1	Maintenance work.....	27
7.2	Cleaning the housing.....	27
7.3	Performing a leak test.....	27
<b>8</b>	<b>Help with faults</b> .....	<b>29</b>
8.1	Troubleshooting.....	29
8.1.1	Error codes.....	29
8.1.2	Customer service.....	30
<b>9</b>	<b>Taking out of service and disposal</b> .....	<b>31</b>
9.1	Taking out of service.....	31
9.2	Disposal.....	31
9.3	Returning the instrument.....	31
<b>10</b>	<b>Appendix</b> .....	<b>32</b>
10.1	Spare parts and accessories.....	32
10.1.1	Spare parts.....	32
10.1.2	Wear parts.....	32
10.1.3	Accessories.....	33

# 1 About this document

This operation manual is applicable for all variants of the instrument. Read this operation manual before operating the instrument and follow the instructions to ensure safe and trouble-free operation.

Keep this operation manual for later use and pass it on to any subsequent user or owner.

BÜCHI Labortechnik AG accepts no liability for damage, faults and malfunctions resulting from not following this operation manual.

If you have any questions after reading this operation manual:

- ▶ Contact BÜCHI Labortechnik AG Customer Service.

<https://www.buchi.com/contact>

## 1.1 Mark-ups and symbols



### NOTE

This symbol draws attention to useful and important information.

- ☑ This character draws attention to a requirement that must be met before the instructions below are carried out.
- ▶ This character indicates an instruction that must be carried out by the user.
- ⇒ This character indicates the result of a correctly carried out instruction.

Mark-up	Explanation
<i>Window</i>	Software Windows are marked-up like this.
<i>Tab</i>	Tabs are marked-up like this.
<i>Dialog</i>	Dialogs are marked-up like this.
<i>[Button]</i>	Buttons are marked-up like this.
<i>[Field names]</i>	Field names are marked-up like this.
<i>[Menu / Menu item]</i>	Menus or menu items are marked-up like this.
<b>Status</b>	Status is marked-up like this.
<b>Signal</b>	Signals are marked-up like this.

## 1.2 Trademarks

Product names and registered or unregistered trademarks that are used in this document are used only for identification and remain the property of the owner in each case.

## 1.3 Connected instruments

In addition to this operation manual, follow the instructions and specifications in the documentation for the connected instruments.

## 2 Safety

### 2.1 Intended use

The instrument is intended for regulating and indicating vacuum within an operating range of 0 mbar to atmospheric pressure. The instrument has been designed and built as an item of laboratory equipment and can be used in conjunction with the following devices:

- Distillation apparatus, especially rotary evaporators (Rotavapor®)
- Vacuum-drying cabinets
- Vacuum pumps

### 2.2 Use other than that intended

Use of any kind other than that described in the section Chapter 2.1 "Intended use", page 6 and any application that does not comply with the technical specifications (see Chapter 3.5 "Technical data", page 12) constitutes use other than that intended.

In particular, the following applications are not permissible:

- Use of the instrument in an environment with a potential risk of explosion or areas which require explosion-safe apparatus.
- Use of the instrument with gases with unknown chemical composition.
- Use of the instrument at pressure above atmospheric.
- Use of the instrument for calibration of other equipment.

Damage or hazards attributable to use of the product other than as intended are entirely at the risk of the user alone.

### 2.3 Staff qualification

Unqualified persons are unable to identify risks and are therefore exposed to greater dangers.

The instrument must be operated by suitably qualified laboratory staff.

The instrument must be commissioned and serviced by suitably qualified technicians.

These operating instructions are aimed at the following target groups:

#### Users

The users are persons that meet the following criteria:

- They have been instructed in the use of the instrument.
- They are familiar with the contents of these operating instructions and the applicable safety regulations and apply them.
- They are able, on the basis of their training or professional experience, to assess the risks associated with the use of the instrument.

#### Operator

The operator (generally the laboratory manager and qualified technicians) are responsible for the following aspects:

- The instrument must be correctly installed, commissioned, operated and serviced.
- Only suitably qualified staff must be assigned the task of performing the operations described in these operating instructions.
- The staff must comply with the local applicable requirements and regulations for safe and hazard-conscious working practices.
- Safety-related incidents that occur while using the instrument should be reported to the manufacturer (quality@buchi.com).

### BUCHI service technicians

Service technicians authorized by BUCHI have attended special training courses and are authorized by BÜCHI Labortechnik AG to carry out special servicing and repair measures.

## 2.4 Personal protective equipment

Depending on the application, hazards due to heat and/or corrosive chemicals may arise.

- ▶ Always wear appropriate personal protective equipment such as safety goggles, protective clothing and gloves.
- ▶ Make sure that the personal protective equipment meets the requirements of the safety data sheets for all chemicals used.

## 2.5 Warning notices in this document

Warning notices warn you of dangers that can occur when handling the instrument. There are four danger levels, each identifiable by the signal word used.

Signal word	Meaning
DANGER	Indicates a danger with a high level of risk which could result in death or serious injury if not prevented.
WARNING	Indicates a danger with a medium level of risk which could result in death or serious injury if not prevented.
CAUTION	Indicates a danger with a low level of risk which could result in minor or medium-severity injury if not prevented.
NOTICE	Indicates a danger that could result in damage to property.

## 2.6 Warning symbols

The following warning symbols are displayed in this operation manual or on the instrument.

Symbol	Meaning
	General warning

## 2.7 Residual risks

The instrument has been developed and manufactured using the latest technological advances. Nevertheless, risks to persons, property or the environment can arise if the instrument is used incorrectly.

Appropriate warnings in this manual serve to alert the user to these residual dangers.

### 2.7.1 Faults during operation

If an instrument is damaged, sharp edges, glass splinters, moving parts or exposed electrical wires can cause injuries.

- ▶ Regularly check instruments for visible damage.
- ▶ If faults occur, switch off the instrument immediately, unplug the power cord and inform the operator.
- ▶ Do not continue to use instruments that are damaged.

## 2.8 Modifications

Unauthorized modifications can affect safety and lead to accidents.

- ▶ Use only genuine BUCHI accessories, spare parts and consumables.
- ▶ Carry out technical changes only with prior written approval from BUCHI.

- ▶ Only allow changes to be made by BUCHI service technicians.

BUCHI accepts no liability for damage, faults and malfunctions resulting from unauthorized modifications.



## 3 Product description

### 3.1 Description of function

The instrument is designed for indicating, adjusting and controlling the vacuum.  
The instrument can be used to:

- Measure and display the pressure
- Regulate to a set pressure
- Regulate the vacuum pump speed
- Start/Stop the vacuum pump
- Regulate a set pressure for a set time period

### 3.2 Configuration

#### 3.2.1 Front view

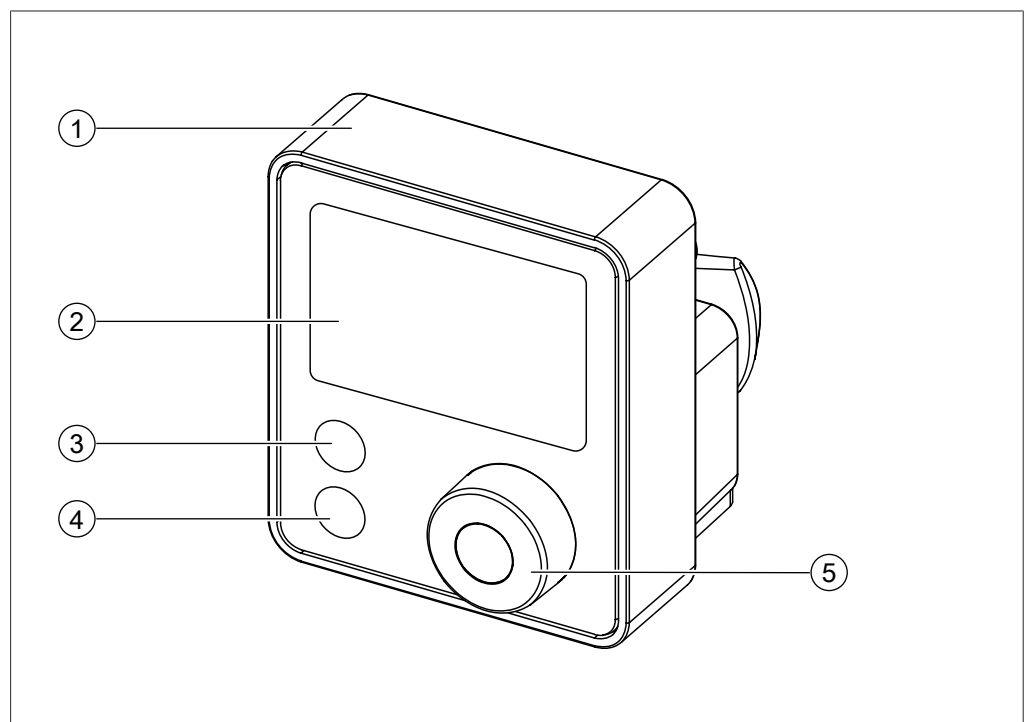

- |   |                           |   |                    |
|---|---------------------------|---|--------------------|
| 1 | Interface cover           | 2 | Display            |
| 3 | Button <b>SET</b>         | 4 | Button <b>STOP</b> |
| 5 | <b>Navigation control</b> |   |                    |

### 3.2.2 Rear view

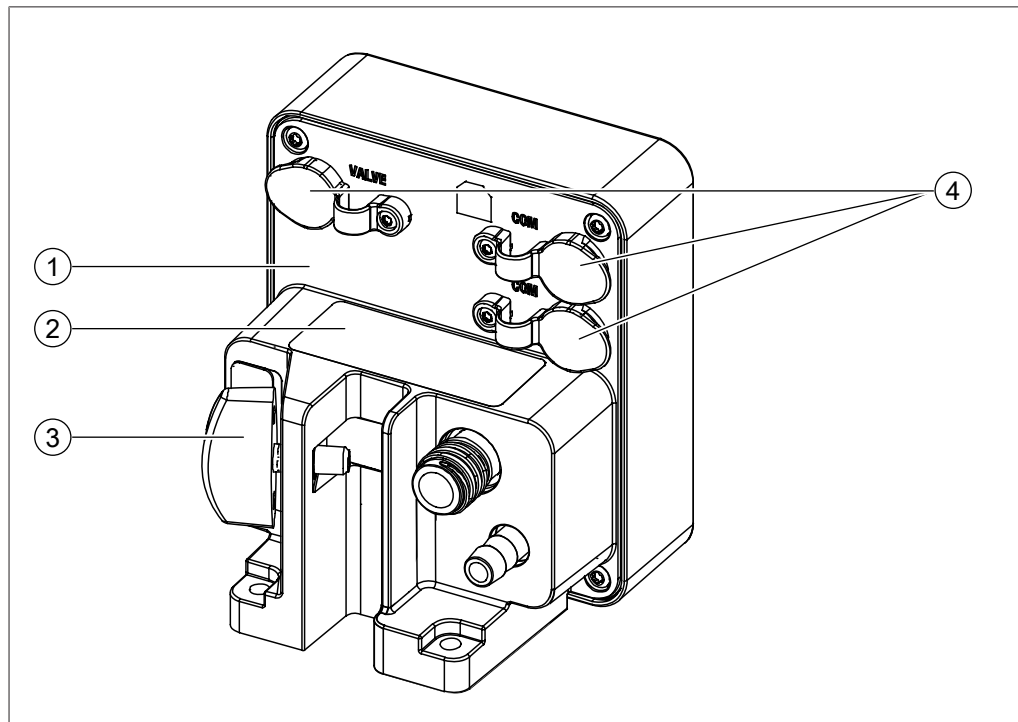

- |   |                      |   |            |
|---|----------------------|---|------------|
| 1 | Interface back cover | 2 | Type plate |
| 3 | Mounting fixture     | 4 | Plug       |

### 3.2.3 Connections

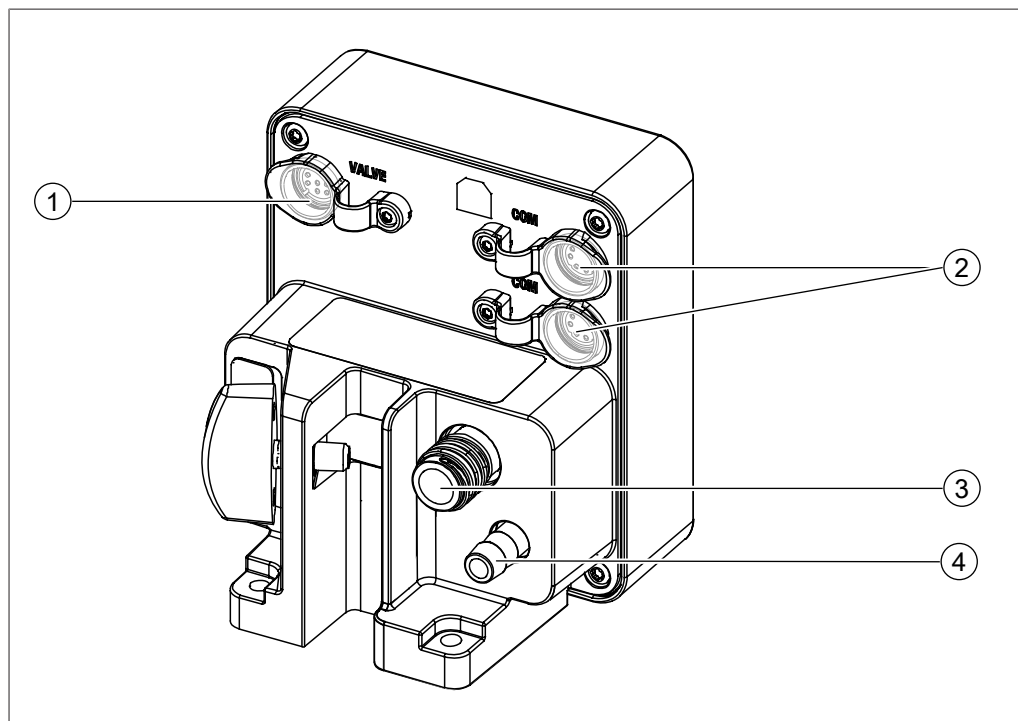

- |   |                         |   |                          |
|---|-------------------------|---|--------------------------|
| 1 | Valve unit <b>VALVE</b> | 2 | Communication <b>COM</b> |
| 3 | Vacuum                  | 4 | Inert gas                |

### 3.2.4 Display layout

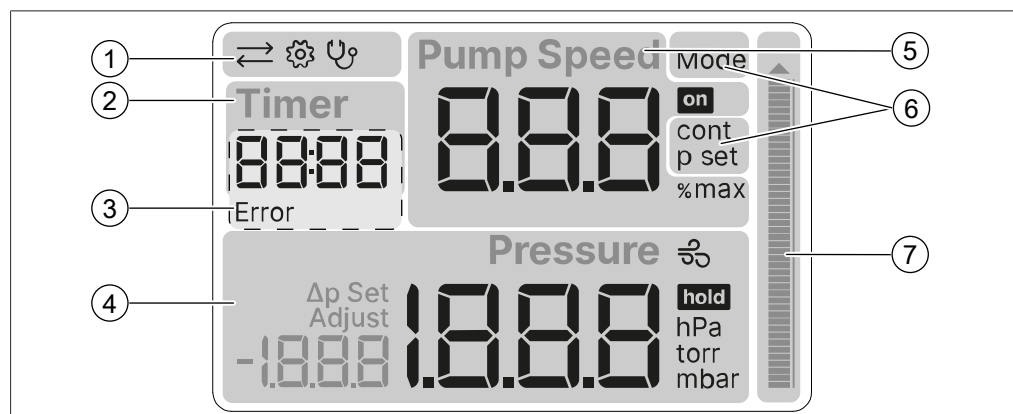

- |   |                    |   |                  |
|---|--------------------|---|------------------|
| 1 | Status bar         | 2 | Timer            |
| 3 | Error code         | 4 | Pressure display |
| 5 | Pump control       | 6 | Operation mode   |
| 7 | Pressure indicator |   |                  |

### 3.2.5 Display symbols

Symbol	Description
↔	BUCHI COM connected
⚙️	Settings
🔍	Leak test
Error	Error occurrence
$\Delta p$	Hysteresis (mbar/hPa/torr) Leak rate (mbar/hPa/torr / min)
Mode	Operating mode
cont	Pump continuously
p set	Vacuum control with set pressure
%max	Maximum pump speed
🌀	System venting active
hold	Hold vacuum control
on	Pump ON
Adjust	One point calibration value
Set	Set value

### 3.3 Scope of delivery



**NOTE**

The scope of delivery depends on the configuration of the purchase order.

Accessories are delivered as per the purchase order, order confirmation, and delivery note.

### 3.4 Type plate

The type plate identifies the instrument. The following type plate is an example. For more details refer to the type plate on the instrument.

The type plate is located at the rear of the instrument.

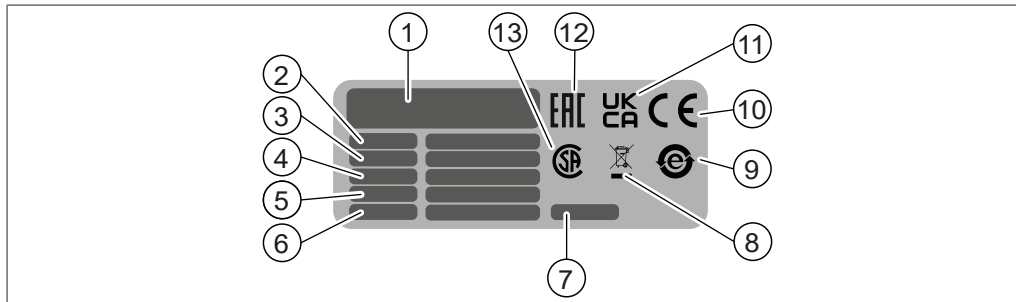

- |  |   |
|--|---|
| 1 Company name and address               | 2 Instrument name                                   |
| 3 Serial number                          | 4 Input voltage range                               |
| 5 Frequency                              | 6 Power consumption maximum                         |
| 7 Year of manufacture                    | 8 Symbol for "Do not dispose of as household waste" |
| 9 Symbol for "electronics recycling"     | 10 Symbol for "CE conformity"                       |
| 11 Symbol for "UK Conformity Assessed"   | 12 Symbol for "Eurasian Conformity" (optional)      |
| 13 Symbol for "CSA certified" (optional) |   |

### 3.5 Technical data

#### 3.5.1 Interface I-180

Specification	Value
Dimensions (W × D × H)	89 mm × 88 mm × 101 mm
Weight	330 g
Connection voltage	30 VDC +5% / -15%
Magnetic valve supply	24 V
Power consumption	5 W
Measurement range	1,400 – 0 mbar
Regulation range	Ambient – 0 mbar
Measurement accuracy	± 2 mbar (after calibration at constant temperature)
Vacuum connection	GL14
IP Code	IP44
Minimum clearance on all sides	none
Controller	3" Dark segment display
Certificate	CB, CE, UL/CSA

### 3.5.2 Ambient conditions

For indoor use only.

Specification	Value
Max. altitude above sea level	2,000 m
Ambient and storage temperature	5 – 40 °C
Max. relative humidity	80% for temperatures up to 31 °C decreasing linearly to 50% relative humidity at 40 °C

### 3.5.3 Materials

Component	Material
Casing	PBT
Vent tube connection	PP
Pressure sensor	Al <sub>2</sub> O <sub>3</sub> 96%

### 3.5.4 Installation site

- The installation site meets the safety requirements. See Chapter 2 "Safety", page 6
- The installation site meets the specifications according to the technical data (e.g. weight, dimension, etc.). See Chapter 3.5 "Technical data", page 12
- The installation site has no obstacles (e.g. water taps, drains, etc.).
- The installation site is not exposed to external thermal loads, such as direct solar radiation.
- The installation site has enough space that cables / tubes can be routed safely.
- The installation site meets the requirements for the connected devices. See related documentation.
- The installation site is in a well ventilated area.
- The instrument is required to be installed on a Rotavapor®, vacuum pump or a laboratory stand.

## 4 Transport and storage

### 4.1 Transport



#### NOTICE

##### Risk of breakage due to incorrect transportation

- ▶ Make sure that the instrument is fully dismantled.
- ▶ Pack all instrument components properly to prevent breakage. Use the original packaging whenever possible.
- ▶ Avoid sharp movements during transit.

- 
- ▶ After transporting, check the instrument and all glass components for damage.
  - ▶ Damage that has occurred in transit should be reported to the carrier.
  - ▶ Keep packaging for future transportation.

### 4.2 Storage

- ▶ Make sure that the ambient conditions are complied with (see Chapter 3.5 "Technical data", page 12).
- ▶ Wherever possible, store the instrument in its original packaging.
- ▶ After storage, check the instrument, all seals and tubing for damage and replace if necessary.

### 4.3 Lifting the instrument

- ▶ Lift the instrument at the points indicated.

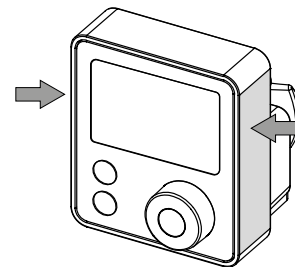

## 5 Installation

### 5.1 Installing the interface

The interface is designed to be mounted on BUCHI instruments or a laboratory stand.

#### 5.1.1 Installing on the Rotavapor®



##### NOTE

The interface is designed to be mounted on a Rotavapor® R-80.

- ▶ Remove and discard the two screws on the Rotavapor® R-80 tower.

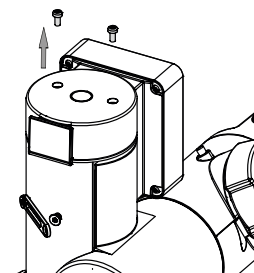

- ▶ Remove the mounting fixture.

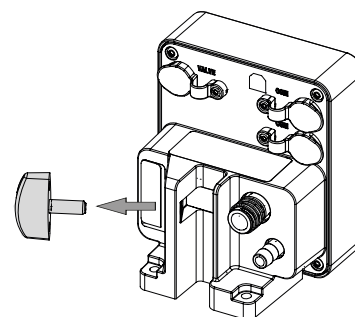

- ▶ Position the interface on the Rotavapor® R-80 tower.

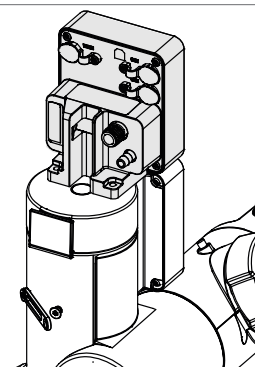

- ▶ Mount the interface with the long screws from the screw set shipped with the interface.
- ▶ Tighten the screws hand-tight. (Max. **0.8 Nm**)

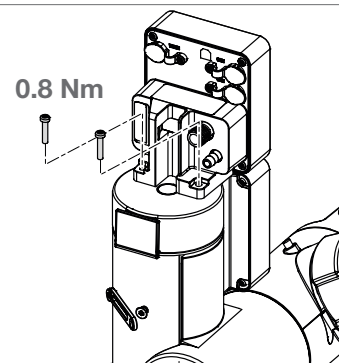

- ▶ Re-install the mounting fixture.

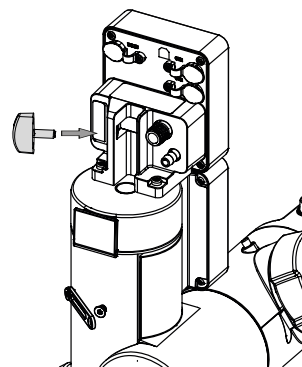

- ▶ Connect the instrument. See additional chapter according to the delivered components.

### 5.1.2 Installing on the vacuum pump



#### NOTE

The interface is designed to be mounted on a Vacuum Pump V-80 or Vacuum Pump V-180.

- ▶ Position the interface holder.

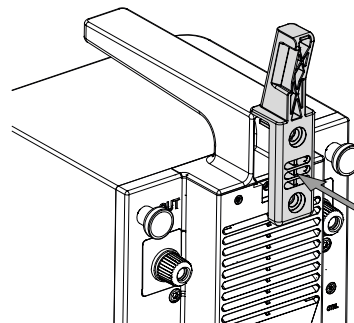

Vacuum Pump V-180

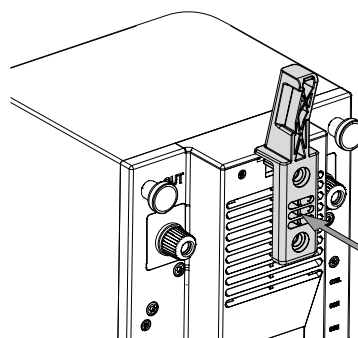

Vacuum Pump V-80

- ▶ Tighten the knurled-head screw.

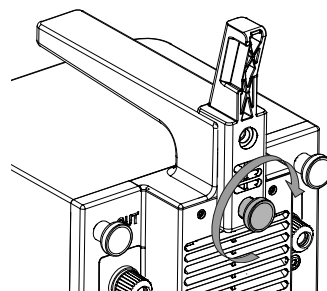



- ▶ Slide the interface onto the interface holder.
- ▶ Position the interface.

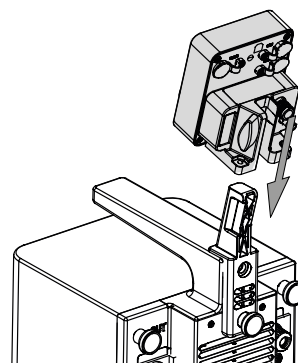

- ▶ Tighten the mounting fixture.

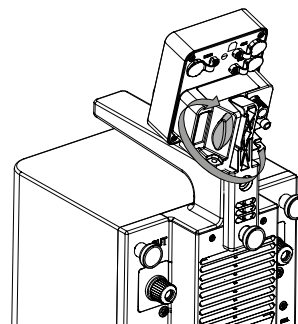

- ▶ Connect the instrument. See additional chapter according to the delivered components.

### 5.1.3 Installing on a laboratory stand

- ▶ Slide the interface onto the laboratory stand.
- ▶ Position it in place.
- ▶ Tighten the mounting fixture.

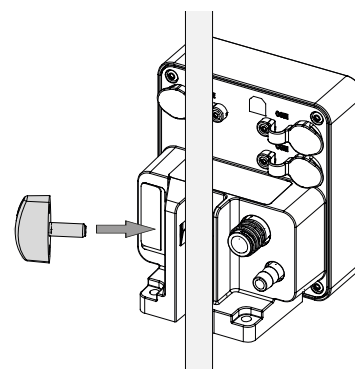

- ▶ Connect the instrument. See additional chapter according to the delivered components.

## 5.2 Connecting the BUCHI communication cable

Precondition:

- The Interface I-80 / I-180 is installed.
- ▶ Plug the communication cable into the interface.
- ▶ Connect the communication cable to the Rotavapor® or the vacuum pump.

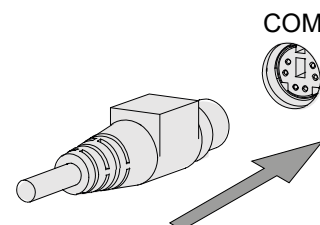

- ▶ Clamp the cable through the fixture.

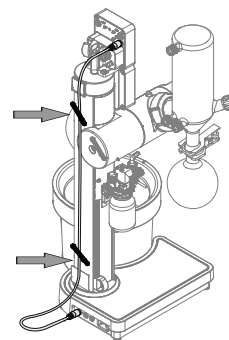

## 5.3 Connecting vacuum

### 5.3.1 Connecting the vacuum pump

- ▶ Connect the vacuum pump. See additional manual according to purchase order.



### 5.3.2 Connecting the valve unit



#### NOTE

The valve unit is only used if a central vacuum system is used.

Precondition:

- The Woulff bottle with valve unit is installed.
- The Interface I-180 is installed.
- ▶ Cut the hose to needed lengths.

Recommended hose lengths:

**400 mm**

(Condenser to Woulff bottle)

**700 mm**

(Interface to Woulff bottle)

**900 mm**

(Vacuum system to Woulff bottle)

- ▶ Install the vacuum hose onto the hose nipples.

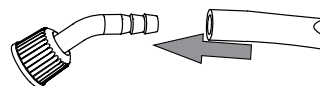

- ▶ Attach the hose to the condenser.

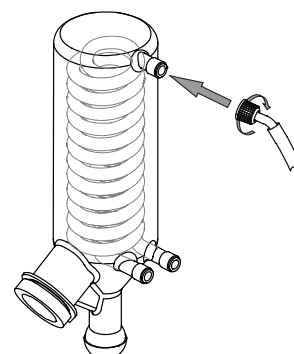

- ▶ Attach the hose to the Woulff bottle connection 1.

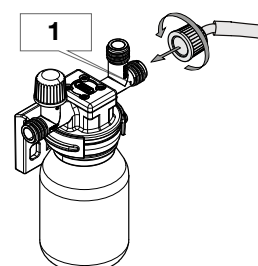

- ▶ Attach the hose to the Woulff bottle connection **PUMP**.

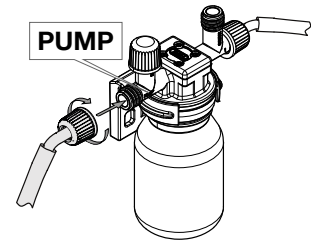

- ▶ Attach the hose to the Woulff bottle connection **CONTR**.

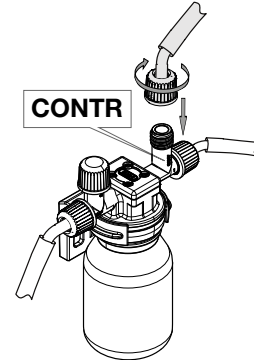

- ▶ Attach the hose to the interface.

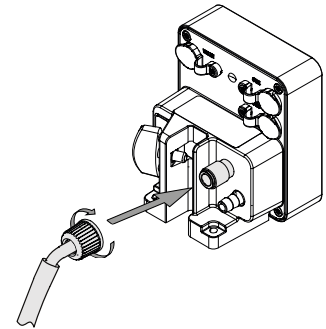

- ▶ Plug the valve unit cable into the interface connection **VALVE**.

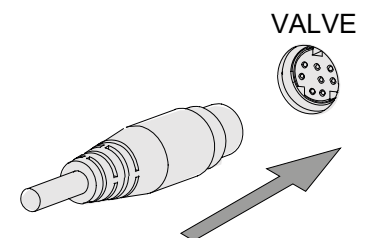

- ▶ Clamp the cable through the fixture.

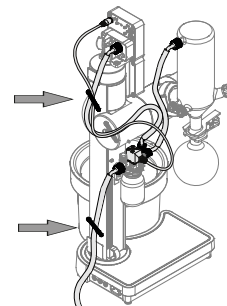

## 6 Operation

### 6.1 Main functions in p set mode

#### 6.1.1 Start or hold the vacuum control

▶ Push the *navigation control*.

⇒ Activates the function.

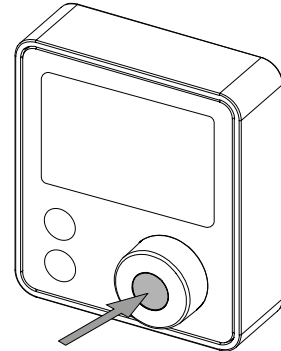

#### 6.1.2 Changing the set pressure

▶ Turn the *navigation control*.

⇒ Changes the symbol or value.

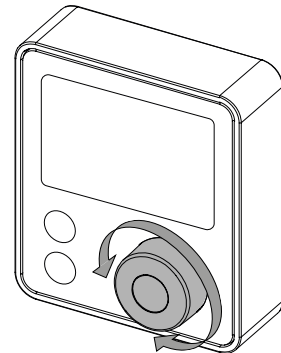

#### 6.1.3 Stop the vacuum control

▶ Touch the **STOP** button.

⇒ Stops the vacuum control and fully aerates the system.

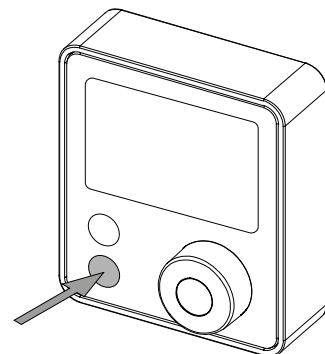

### 6.1.4 Aerating the system

- ▶ Push and hold the *navigation control*.
- ⇒ System is aerating.
- ⇒  symbol appears.

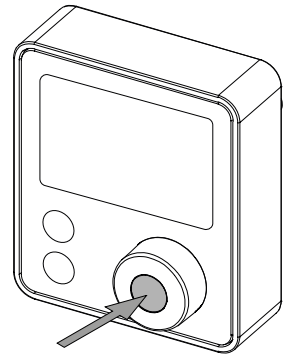

- ▶ Release the *navigation control*.
- ⇒ Instrument holds the pressure.
- ⇒  symbol appears.

## 6.2 Main functions in cont mode

### 6.2.1 Starts or holds the vacuum pump

- ▶ Push the *navigation control*.
- ⇒ Activates the function.

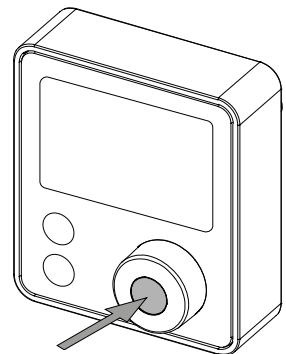

### 6.2.2 Control the vacuum pump speed

- ▶ Turn the *navigation control*.
- ⇒ Changes the symbol or value.

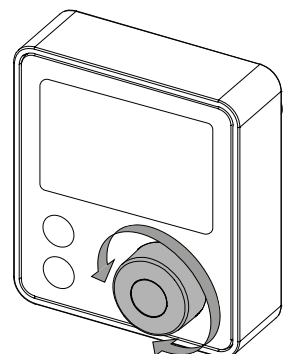

### 6.2.3 Stop the vacuum pump

- ▶ Touch the **STOP** button.
- ⇒ Stops the vacuum control and fully aerates the system.

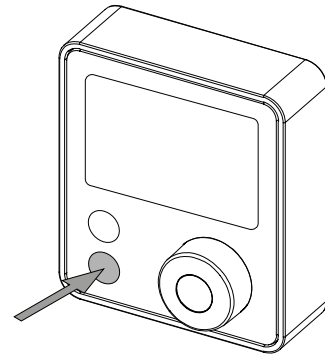

### 6.2.4 Aerating the system

- ▶ Push and hold the **navigation control**.
- ⇒ System is aerating.
- ⇒  symbol appears.

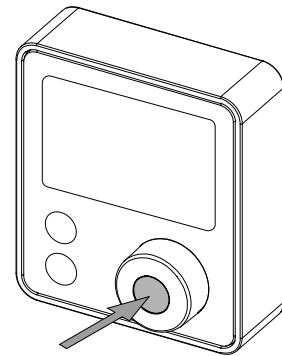

- ▶ Release the **navigation control**.
- ⇒ Instrument holds the pressure.
- ⇒ **hold** symbol appears.

## 6.3 Settings

### 6.3.1 Setting the pressure

This setting is only possible in the **p set** mode.

#### Navigation path

→  → Set pressure

- ▶ Touch the **SET** button.
- ⇒ **Settings** symbol appears.
- ⇒ Blinking value is active.

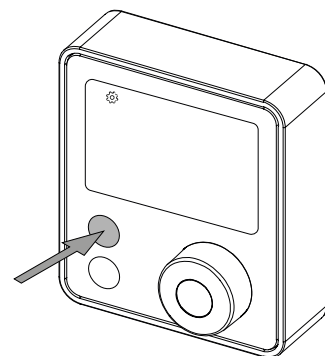

- ▶ Turn the **navigation control**.

⇒ Changes the value.

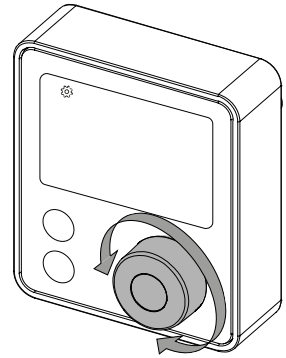

- ▶ Push the **navigation control**.

⇒ Exits the settings.

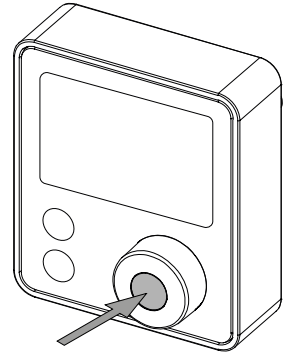

### 6.3.2 Setting the pump speed

This setting is only possible in the **cont** mode.

#### Navigation path

→  → Set pump speed

- ▶ Touch the **SET** button.

⇒ **Settings** symbol appears.

⇒ Blinking value is active.

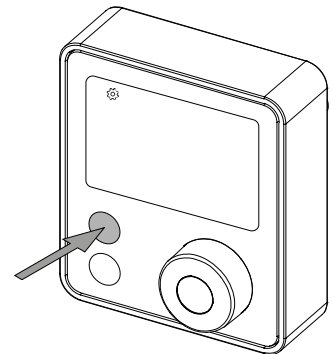

- ▶ Turn the **navigation control**.

⇒ Changes the value.

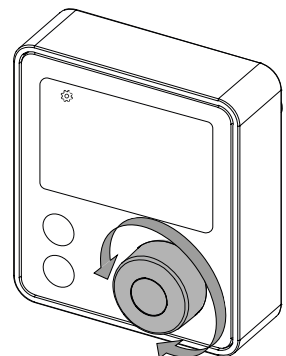

- ▶ Push the **navigation control**.
- ⇒ Exits the settings.

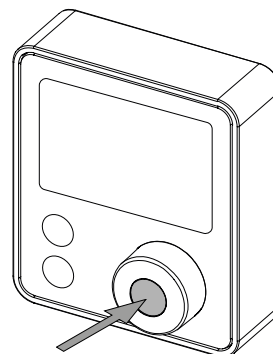

### 6.3.3 Setting to default settings

Precondition:

- All connected instruments are switched off.
- ▶ Press and hold the **navigation control**.
- ▶ Switch on a connected instrument.
- ▶ Wait until the indication bar is fully loaded.
- ⇒ Interface is reset to default settings.

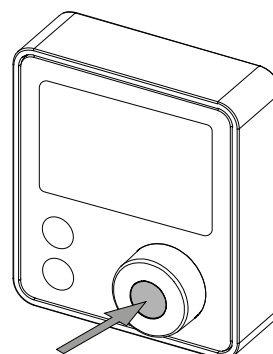

## 6.4 Advanced settings

### 6.4.1 Advanced settings with vacuum pump

Navigation path	Symbol	Description
Operation mode	<b>Mode</b>	Changing the operation mode between pressure control <b>p set</b> and continuous <b>cont</b> mode.
Timer	<b>Timer</b>	Setting a operation timer in minutes. <ul style="list-style-type: none"> <li>• <b>P set</b> mode: Vacuum control stops and system aerates when timer is finished.</li> <li>• <b>Cont</b> mode: Vacuum pump stops and system aerates when timer is finished.</li> </ul>
Maximum pump speed	<b>%max</b>	<b>P set</b> mode: Setting the maximum pump speed limit in operation.
Leak test		Setting to perform an automatic leak test.
Pressure unit	<b>mbar, torr, hPa</b>	Changing the pressure unit.
Pressure calibration	<b>Adjust</b>	Setting an offset for the pressure calibration.



▶ Touch the **SET** button and the **navigation control**.

- ⇒ **Settings** symbol appears.
- ⇒ Blinking symbol or value is active.

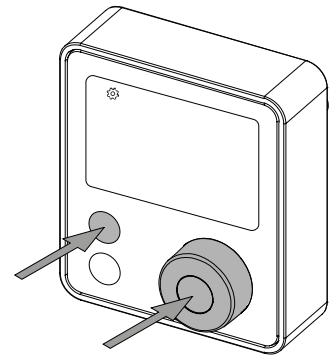

▶ Turn the **navigation control**.

- ⇒ Changes the symbol or value.

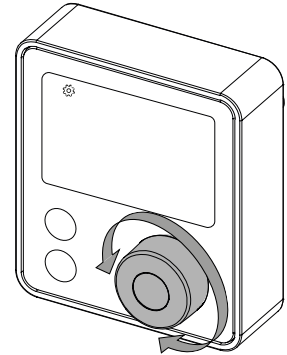

▶ Touch the **SET** button to navigate through the settings.

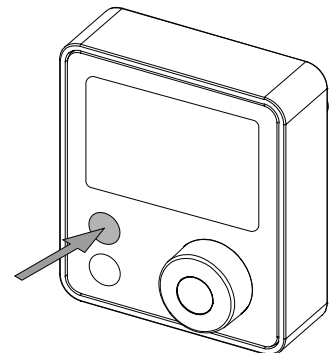

### 6.4.2 Advanced settings with valve unit

This setting is only possible if there is a house vacuum available.

Navigation path	Symbol	Description
Hysteresis	$\Delta p$	Changing the operation hysteresis between automatic <b>A</b> and manual <b>1 – 50 mbar</b> to adjust the pressure regulation range.
Timer	<b>Timer</b>	Setting a operation timer in minutes. <ul style="list-style-type: none"> <li>• <b>P set</b> mode: Vacuum control stops and system aerates when timer is finished.</li> <li>• <b>Cont</b> mode: Vacuum pump stops and system aerates when timer is finished.</li> </ul>
Leak test		Setting to perform an automatic leak test.
Pressure unit	<b>mbar, torr, hPa</b>	Changing the pressure unit.
Pressure calibration	<b>Adjust</b>	Setting an offset for the pressure calibration.

- ▶ Touch the **SET** button and the **navigation control**.

⇒ **Settings** symbol appears.

⇒ Blinking symbol or value is active.

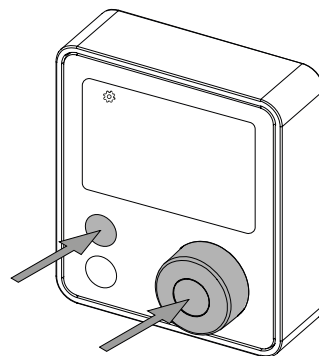

- ▶ Turn the **navigation control**.

⇒ Changes the symbol or value.

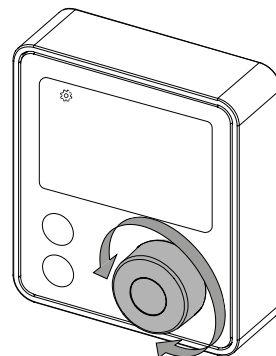

- ▶ Touch the **SET** button to navigate through the settings.

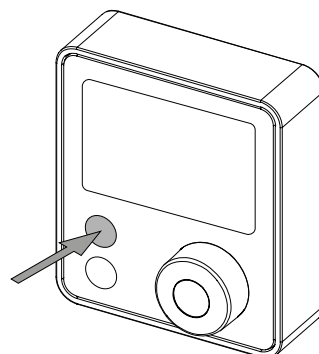

## 7 Cleaning and servicing



### NOTE

- ▶ Carry out only the service and cleaning operations described in this section.
- ▶ Do not carry out any servicing and cleaning operations that involve opening the housing.
- ▶ Use only genuine BUCHI spare parts in order to ensure correct operation and preserve the warranty.
- ▶ Carry out the service and cleaning operations described in this section to extend the lifetime of the instrument.

### 7.1 Maintenance work

Action	Weekly	Additional information
7.2 Cleaning the housing	1	
7.3 Performing a leak test	1	

1 - Operator

### 7.2 Cleaning the housing

- ▶ Wipe down the housing with a damp cloth.
- ▶ If heavily soiled, use ethanol or a mild detergent.
- ▶ Wipe down the display with a damp cloth.

### 7.3 Performing a leak test

Precondition:

- The Rotavapor® is prepared.

- ▶ Set the leak test.  
See Chapter 6.4.1 "Advanced settings with vacuum pump", page 24.  
See Chapter 6.4.2 "Advanced settings with valve unit", page 25.

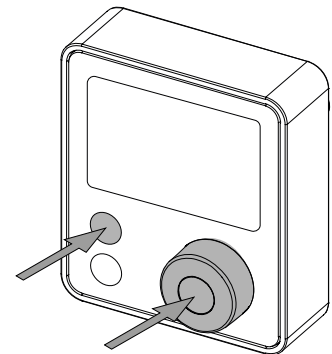

- ▶ Push the **navigation control**.  
⇒ Leak test starts.
- ▶ Check if the pressure reaches 50 mbar.  
⇒ If it does not reach the pressure, there is a leakage. See Chapter 8 "Help with faults", page 29.

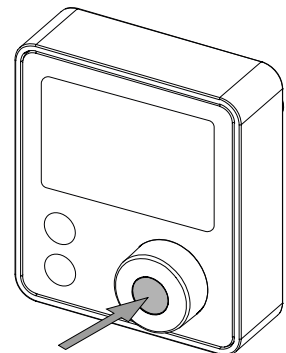

► Wait until the timer finishes.

⇒ Leak rate appears.

**$\Delta p$  = mbar/min** or

**$\Delta p$  = Torr/min** or

**$\Delta p$  = hPa/min**

$\Delta p$   
-1.0.0.0

## 8 Help with faults

### 8.1 Troubleshooting

Problem	Possible cause	Action
Instrument does not work	BUCHI communication cable is not connected	▶ Plug-in the communication cable. See Chapter 5.2 "Connecting the BUCHI communication cable", page 17.
	Main switch of the connected instrument with power supply is off	▶ Switch on the main switch of the connected instrument with power supply.
Aeration not possible or compromised	Dust or particles in the aeration valve	▶ Blow out the dust and particles with pressurized air.
Displayed pressure is wrong	Wrong calibration	▶ Do the one-point calibration in the advanced setting.

#### 8.1.1 Error codes

Error code	Description	Action
140	Supply voltage too low	▶ Check the power supply. ⇒ If the error code is still indicated. ▶ Contact BUCHI Customer Service.
150	Maximum pressure exceeded	▶ Check possible causes of the system overpressure.
180	Pressure sensor not calibrated	▶ Contact BUCHI Customer Service.
181	Pressure sensor defective	▶ Contact BUCHI Customer Service.
199	Initialization error	▶ Contact BUCHI Customer Service.
391	Valve unit driver error	▶ Contact BUCHI Customer Service.

#### Error codes from connected BUCHI Vacuum Pump

Error code	Description	Action
116	Fill level sensor removed during operation	▶ Check the sensor connection.
117	Fill level sensor reached	▶ Empty the secondary condenser receiving flask.
650	No fan response	▶ Make sure the fan can rotate. ⇒ If the error code is still indicated. ▶ Contact BUCHI Customer Service.
651	Housing open	▶ Make sure the housing is closed. ⇒ If the error code is still indicated. ▶ Contact BUCHI Customer Service.

Error code	Description	Action
681	Electronic circuitry overheated	<ul style="list-style-type: none"> <li>▶ Switch off the instrument.</li> <li>▶ Let the instrument cool down.</li> <li>▶ Clean the air intake.</li> <li>▶ Switch on the instrument.</li> <li>⇒ If the error code is still indicated.</li> <li>▶ Contact BUCHI Customer Service.</li> </ul>
682	No reliable rotation measurement	▶ Contact BUCHI Customer Service.
683	Wrong turning direction	▶ Contact BUCHI Customer Service.
685	Motor blocked	▶ Contact BUCHI Customer Service.
686	Supply voltage too low	<ul style="list-style-type: none"> <li>▶ Check the power supply.</li> <li>⇒ If the error code is still indicated.</li> <li>▶ Contact BUCHI Customer Service.</li> </ul>

### 8.1.2 Customer service

Only authorized service personnel are allowed to perform repair work on the instrument which is not described in this manual. Authorization requires a comprehensive technical training and knowledge of possible dangers which might arise when working at the instrument. Such training and knowledge can only be provided by BUCHI.

The customer service and support offers the following support:

- Spare part delivery
- Repairs
- Technical advice

Addresses of official BUCHI customer service offices can be found on the BUCHI website.

[www.buchi.com](http://www.buchi.com)

## 9 Taking out of service and disposal

### 9.1 Taking out of service

- ▶ Switch off the instrument.
- ▶ Disconnect the instrument from the power supply.
- ▶ Remove all connections.
- ▶ Clean the instrument.

### 9.2 Disposal

The operator is responsible for proper disposal of the instrument.

- ▶ When disposing the equipment observe the local regulations and statutory requirements regarding waste disposal.
- ▶ When disposing, observe the disposal regulations of the materials used. For the used materials see Chapter 3.5 "Technical data", page 12 or the material labeling on the parts.

### 9.3 Returning the instrument

Before returning the instrument, contact the BÜCHI Labortechnik AG Service Department.

<https://www.buchi.com/contact>

## 10 Appendix

### 10.1 Spare parts and accessories



Use only genuine BUCHI consumables and spare parts in order to ensure correct, safe and reliable operation of the system.





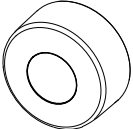

#### NOTE

Any modifications of spare parts or assemblies are only allowed with the prior written permission of BUCHI.



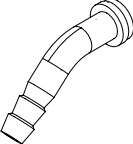

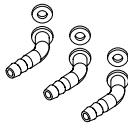
#### 10.1.1 Spare parts

	Order no.	Image
Navigation control knob	11074581	
Receiving vessel, GL 40, 125 mL, P+G For Woulff bottle	047233	
Woulff bottle holder	11075161	



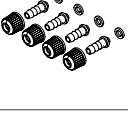
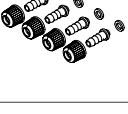

#### 10.1.2 Wear parts

	Order no.	Image
Seal Woulff bottle	047165	
Hose barb, bent, GL 14, incl. silicone seal	018916	
Hose barbs, set. 2 pcs, bent (1), straight (1), GL 14, silicone seal Content: Hose barbs, cap nuts, seals	041939	
Hose barbs, set. 3 pcs, bent, GL 14, silicone seal Content: Hose barbs, seals.	041987	
Hose barbs, set. 4 pcs, bent GL 14, silicone seal Content: Hose barbs, cap nuts, seals	037287	

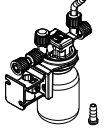

	Order no.	Image
Hose barbs, set. 4 pcs, bent, GL 14, EPDM seal Content: Hose barbs, cap nuts, seals.	043129	
Hose barbs, set. 4 pcs, bent, GL 14, FPM seal Content: Hose barbs, cap nuts, seals.	040295	
Hose barbs, set. 4 pcs, straight, GL 14, EPDM seal Content: Hose barbs, cap nuts, seals.	043128	
Hose barbs, set. 4 pcs, straight, GL 14, FPM seal Content: Hose barbs, cap nuts, seals.	040296	
Hose barbs, set. 4 pcs, straight, GL 14, silicone seal Content: Hose barbs, cap nuts, seals	037642	
Hose barbs, set. 6 pcs, bent (4), straight (2), GL 14, silicone seal Content: Hose barbs, cap nuts, seals.	038000	

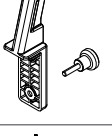
### 10.1.3 Accessories

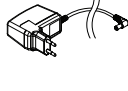
	Order no.	Image
Woulff bottle, 125 mL, P+G, incl. holder For trapping particles and droplets and for pressure equalization.	11075622	
Valve unit, Woulff bottle, 125 mL, P+G, incl. holder Non-return valve and condensate trap	11075630	
Interface holder To install the Interface I-80 / I-180 on the Vacuum pump V-80 / V-180	11075588	
Stand. V stand with rod, 600 mm Used as a holder for interface when it cannot be mounted on an instrument.	048891	
Power adapter. 30 V, 30 W, frequency 50/60 Hz In combination with Mini-DIN to DC-Jack adapter to power the interface.	11060669	

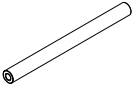
	<b>Order no.</b>	<b>Image</b>
Mini-DIN to DC-Jack, 300 mm	11062266	
Tubing, synthetic rubber, Ø6/13 mm, black, per m Use: Vacuum	11063244	

### Communication cable

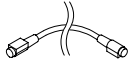
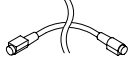
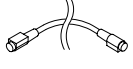
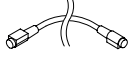
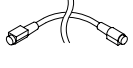
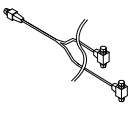
	<b>Order no.</b>	<b>Image</b>
Communication cable. BUCHI COM, 0.3 m, 6p	11058705	
Communication cable. BUCHI COM, 0.9 m, 6p	11070540	
Communication cable. BUCHI COM, 1.8 m, 6p	11058707	
Communication cable. BUCHI COM, 5.0 m, 6p	11058708	
Communication cable. BUCHI COM, 15 m, 6p	11064090	
Communication cable. Mini-DIN, Y-piece, with double-sided connectors, 2 m To connect 2 Rotavapor® systems with valve unit to 1 vacuum pump	11080283	





11594509 | A en

---

We are represented by more than 100 distribution partners worldwide.  
Find your local representative at:

[www.buchi.com](http://www.buchi.com)

Quality in your hands

---